

VAZ® 800 XL MW

Vecoplan®



VAZ® 800 XL MW Medical Waste Shredder

The Vecoplan VAZ® 800 XL MW Medical Waste Rotary Grinder is especially designed for the processing of sterilized medical waste - with features such as stainless steel bottom plates, additional drip plates, hard-faced holders for highly abrasive material and optimized PLC programming designed specifically for medical waste to guarantee the highest processing efficiency available in the industry.

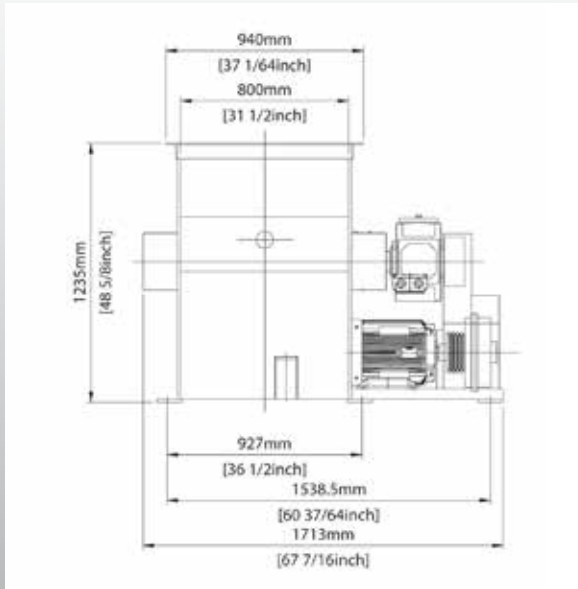

front view

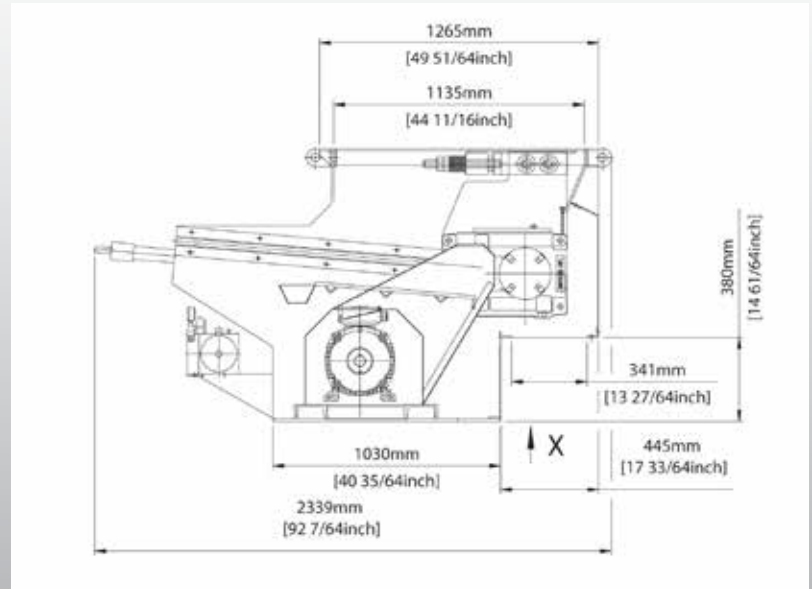

side view

Specifications

Hopper Opening	inch	32x45
Hopper Volume	cubic yards	1.3
Rotor Diameter	inch	15
No. of Cutters	qty	40 (40x40)
Rotor Speed	rpm	120
Drive Motor HP	HP	40
Feed System	HP/speed	1.5 - 2 / 2
Machine Weight	lbs	5,500
Voltage	V/PH/Hz	460/3/60

Options

- Multiple Rotor Configurations
- Pneumatic Pick-Up Hoods
- Custom Hoppers
- Abrasion Resistant Screens
- Control Integration
- Turn-Key Installation w/Custom Conveyor Systems Engineering and Material Handling Equipment

Features

- Double Row of Cutters
- Hardfaced Cutter Holders
- Stainless Steel Access Cover
- Special Hopper
- Nylon Guid rails
- A-R Ram Plate and Floor
- Drainage Gutter
- Serrated Ram
- Sloped Floor (certain models)
- Low Speed / High Torque Design
- Tramp Metal Protection
- Precision Hydraulic Process Ram
- 4-Way, Indexable Cutting Inserts
- High Output Torsion Point Cutting Rotor
- Rugged Hydraulics
- Lifetime Limited Warranty on Cutting Rotor
- Oversized Drivetrain
- Heavy Spherical Roller Bearings
- PLC Control Panel
- ISO 9001 Manufactured